

Keep safe



SD Series

LIFE SCIENCE WATER APPARATUS

LeveLuk<sup>SD</sup> 501

LeveLuk<sup>DX</sup> II

LeveLuk<sup>Jr</sup> II

Continuous Ionized KANGEN and  
Strong Acidic Water Generator

# Operation Manual

- Please read this manual carefully and thoroughly before operation
- This unit must be used correctly, according to the manufacturers instructions
- Please keep this manual in a safe place for future reference

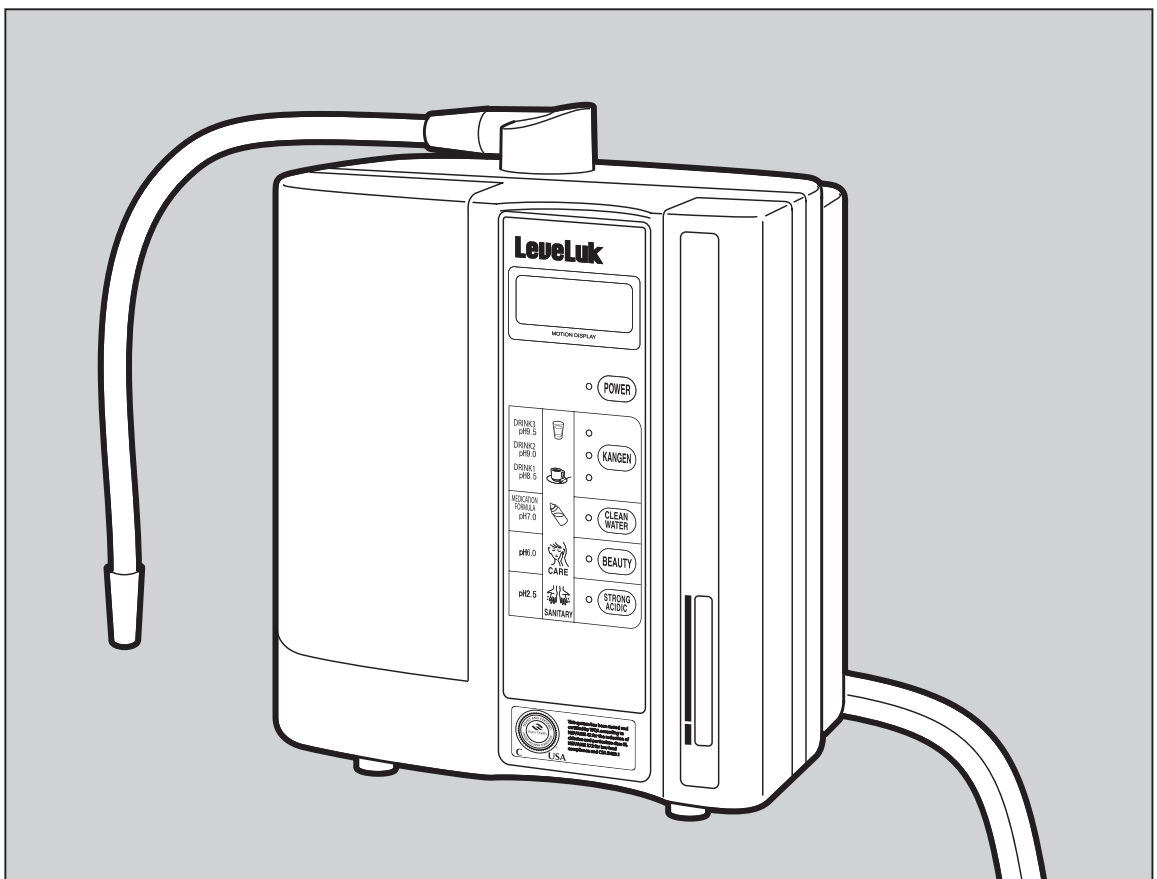

Thank you very much for purchasing our <LeveLuk SD 501> <LeveLuk DX II> <LeveLuk Jr II> .  
Please read through the Operation Manual carefully for your safety before using the product.  
Please keep this manual in a safe place for future use.

## Los Angeles (US Headquarters)

4115 Spencer Street Torrance CA 90503 U.S.A.  
tel.1-310-542-7700 fax.1-310-542-1700

## New York

36-36 33rd St. 4th Floor Suite 403, Long Island City, NY 11106 USA  
tel.1-718-784-2110 fax.1-718-784-2103

## Chicago

1154 S. Elmhurst Rd. Mount Prospect, IL 60056-4241 USA  
tel.1-847-437-8200 fax.1-847-437-8201

## Texas

739 Justin Road, Rockwall, TX 75087 U.S.A.  
tel.1-972-722-7499 fax.1-972-722-7402

## Florida

8803 Futures Drive, Unit01, Orlando, FL 32819 U.S.A.  
tel.1-407-601-5963 fax.1-407-730-3335

## Seattle

19009 33rd Avenue, W., suite 201, Lynnwood, WA 98036 U.S.A.  
tel.1-425-640-2222 fax.1-425-672-8946

## Honolulu

Ala Moana Pacific Center, Suite 711, 1585 Kapiolani Boulevard,  
Honolulu, Hawaii 96814 U.S.A.  
tel.1-808-949-5300 fax.1-808-949-5336

## Vancouver

Suite 678-5900 N0.3 Road Richmond, BC V6X 3P7 Canada.  
tel.1-604-214-0065 fax.1-604-214-0067

## Toronto

75 Watline Avenue, Suite 138 Mississauga, ON L4Z 3E5, Canada  
tel.1-905-507-1200 fax. 1-905-507-1233

## Mexico

Commercial Plaza Tanarah Avenida Vasconcelos 345  
Colonia Santa Engracia 66267  
San Pedro Garza Garcia, Nuevo Leon, Mexico  
tel.52-81-8242-5500 fax.52-81-8242-5549

## Germany

Immermannstr.33 40210 Düsseldorf Germany  
tel.49-211-9365-7000 fax.49- 211-9365-7027

## France

24 rue du Banquier 75013 Paris France  
tel.33-01-4707-5565 fax.33-01-4707-5595

## Italy

Via roccaporena 40-42 00191 Roma Italy  
tel.39-06-3330-670 fax.39-06-3321-3189

## Australia

15/33 Waterloo Rd Macquarie Park  
New South Wales 2113, Australia  
tel.61-2-9878-1100 fax.61-2-9878-1200



C USA

The LevelLuk SD501 has been tested and certified by WQA according to NSF/ANSI 42 for the reduction of chlorine and particulate class III, NSF/ANSI 372 for low lead compliance and CSA B483.1 See performance data sheet for specific performance data.



ISO 9001:2008  
ISO 13485:2003  
Management  
System

www.tuv.com  
ID 9105070879

## Philippines

21st floor, 6788 Ayala Avenue, Makati Sky Tower,  
Makati City, Philippines  
tel.63-2-519-5508 fax.63-2-519-1923

## Singapore

111 North Bridge Road, 25-04 Peninsula Plaza Singapore 17909  
tel.65-6720-7501 fax.65-6720-7505

## Malaysia

Unit 29-7, 7F, The Boulevard Mid Valley City, Lingkaran Syed Putra,  
59200, Kuala Lumpur, Malaysia  
tel.60-3-2282-2332 fax.60-3-2282-2335

## Hong Kong

Unit 1615-17, 16th Floor Miramar Tower, 132 Nathan Rd.,  
Tsim Sha Tsui, Kowloon, Hong Kong.  
tel.852-2154-0077 fax.852-2154-0027

## Taiwan

Nanjing East Road, 3-337 12F B Room  
Xiong Shan Qu, Taipei City, Taiwan  
tel.886-2-2713-2936 fax.886-2-2713-2938

## Korea

7F 118-3, Nonhyun-dong Gangnam-gu Seoul, Korea  
tel.82-2-546-8120 fax.82-2-546-8127

## Sapporo

Regent Building 7F  
1-5, Nishi2chome, Kita2jo, Chuo-ku, Sapporo-city, Hokkaido,  
Japan 060-0002  
tel.81-11-223-5678 fax.81-11-223-5680

## Tokyo

Echizenya Building 7F  
1-1-6, Kyobashi Chou-ku, Tokyo, Japan 104-0031  
tel.81-3-5205-6030 fax.81-3-5205-6035

## Sikoku

1313-8, Simojimayama-kou, Saijiyou-city, Ehime, Japan 793-0006  
tel.81-897-58-4115 fax.81-897-58-4116

## Okinawa

4-10-1, Makiminato Urazoe-city, Okinawa, Japan 901-2131  
tel.81-98-878-4132 fax.81-98-878-4141

## Nago

2-15-16, Ohigashi Nago-city, Okinawa, Japan 905-0016  
tel.81-980-51-0616 fax.81-980-51-0628

## Manufacturer:

### Enagic, Inc.

1-40-1, Hosida-kita Katano-city, Osaka, Japan 576-0017  
tel.81-72-893-2290 fax.81-72-893-8007



Brand Name: LevelLuk SD501

Model Number: TYH-401  
Rated Service Flow: 1.1 gallons/minute  
Operating Pressure: Minimum 9 PSI 75 PSI is maximum.  
Operating Temperature:  
Minimum operating Temp40 Maximum is 95 degrees F (35 degrees C)

This system has been tested and certified by WQA according to NSF/ANSI 42 for the reduction of chlorine, taste and odor, and particulate class III, NSF/ANSI 372 for low lead compliance, and CSA B483.1. See performance data sheet for specific performance data.

For use with cold water only.  
Do not use with water that is microbiologically unsafe or of unknown quality without adequate disinfection before or after the system.

Replacement Components  
Replacement filter: Replacement Filter HG-N  
Electrical Requirements

USA 120V 60Hz grounded outlet  
Europe 220V-240V 50/60Hz grounded outlet

Enagic USA  
4115 Spencer Street  
Torrance, CA 90503

# ■ IMPORTANT SAFEGUARDS

---

## • READ ALL INSTRUCTIONS BEFORE USING:

**DANGER** – To reduce the risk of electrocution:

1. Always unplug this product immediately after using.
2. Do not use while bathing.
3. Do not place or store product where it can fall or be pulled into a tub or sink.
4. Do not place in or drop into water or other liquid.
5. Do not reach for a product that has fallen into water. Unplug immediately.

**WARNING** – To reduce the risk of burns, electrocution, fire, or injury.

1. A product should never be left unattended when plugged.
2. Close supervision is necessary when this product is used by, or near children or invalids.
3. Use this product only for its intended use as described in this manual. Do not use attachments for other uses not recommended by the manufacturer.
4. Never operate this product if it has a damaged cord or plug, not working properly, has been dropped or damaged, or has been dropped into water. Return the product to a service center for examination and repair.
5. Keep the cord away from heated surfaces.
6. Never use while sleeping or drowsy.
7. Never drop or insert foreign object(s) into any openings or hose(s).
8. Do not use outdoors or operate where aerosol (spray) products are being used or where oxygen is being administered.
9. Connect this product to a properly grounded outlet only. See Grounding Instructions.

# ■ SAVE THESE INSTRUCTIONS

---

- a) This manual contains instructions for cleaning, user maintenance, and proper operations recommended by the manufacturer such as lubrication, and non-lubrication of this device. All services required by this product must be performed by an authorized service representative, which means that this product contains no user serviceable parts. This product is for household use as stated in this manual and other literature packed with the product.
- b) When a product employing an automatic reset thermal limiter (which shuts off the entire product) is used, please refer to this manual for instructions and warnings.
- c) While the product is in use, please refer to this manual for proper cord maintenance.
- d) The product is intended to be used with water, additives, conditioners, or a product that relies on the conductivity of water for normal operations (electrode type products). The use of baking soda, salt, or other substances to improve the conductivity of the water is stipulated. Please refer to this manual for specific instructions on the proper liquid or additive and the exact amount to be used in conjunction with the product.

# ■ GROUNDING INSTRUCTIONS

---

This product should be grounded. In the event of an electrical short circuit, grounding reduces the risk of electric shock by providing an escape wire for the electric current. This product is equipped with a cord having a grounding wire with a grounding plug. The plug must be plugged into an outlet that is properly installed and grounded.

**DANGER** – Improper use of the grounding plug can result in a risk of electric shock.

If repair or replacement of the cord or plug is necessary, do not connect the grounding wire to either flat blade terminal. The wire with insulation with an outer surface that is green with or without yellow stripes is the grounding wire. Check with a qualified electrician or serviceman if the grounding instructions are not completely understood, or if in doubt as to whether the product is properly grounded.

**For all other grounded, cord connected products** : This product is factory equipped with a specific electric cord and plug to permit connection to a proper electric circuit. Make sure that the product is connected to an outlet having the same configuration as the plug. No adapter should be used with this product. Do not modify the plug provided — if it will not fit the outlet, have the proper outlet installed by a qualified electrician. If the product must be reconnected for use on a different type of electric circuit, the reconnection should be made by qualified service personnel.

**Extension Cords** : If it is necessary to use an extension cord, use only a three wire extension cord that has a three-blade grounding plug, and a three-slot receptacle that will accept the plug on the product. Replace or repair damaged cord.

# Contents

■	Introduction	4
■	Precautions on the use of Beauty Water and Strong Acidic Water as well as KANGEN Water	5
■	Features	6
■	Accessories	7
■	Name of each part	8~9
■	Control panel	10
	• LCD messages and voice guidance	11
1	Installation	12
	• Installing the diverter	13
	• Setting up the unit	14
	• About the power cable	15
2	Usage	16
	• Changing the sound level	17
	• Producing KANGEN Water	18~19
	• Producing Beauty Water	20
	• Producing Strong Acidic Water/Strong KANGEN Water	21~23
	• Producing Clean Water	24
	• Automatic Cleaning	25
3	Replacing the water filter (HG-N)	26~27
4	Safety Precautions	28~29
5	Troubleshooting	30~31
	• Cleaning with the E-Cleaner N	31
6	Options	32
7	Standard Specifications	33
■	After-sales Services	Back of Manual

# Introduction

## • Indicators used in this manual

The marks in this manual indicate areas of importance, and are explained below. Be sure to read the Warning and Caution instructions carefully.



### Level of danger





Indicates an imminently hazardous situation which may result in health hazards if the device is handled in a manner other than described in this manual.



Indicates a potentially hazardous situation which may result in minor or moderate injury if the device is handled in a manner other than described in this manual.

\* All the precautions described here are classified as “ Warning” and “ Attention”.

Any potential hazardous situation which could result in death or serious physical injury are referred to under the sign “ Warning”.







However, other potentially hazardous situations referred to under the sign of “ Attention” can also present serious danger, depending on the case and situation.

All the precautions, therefore, should be observed strictly.

\* The maker of this product is not responsible for any damage to the product or accidents caused by improper use or by disregarding the precautions mentioned in this manual.

\* After reading this manual, please keep it in a safe place for future reference.

## ■ Description of signal marks

Mark	Title	Significance
	General	Used to indicate general precautions, warnings and dangers.
	General	Used to notify general prohibition precautions, warning and danger.
	General	Used to describe behavior of general users.
	Open flames	Used to warn against any behavior that could result, under certain conditions, in the unit catching fire as a result of proximity to flame.
	Prohibition of use at water splashing place, such as, bath or shower room.	Used to prohibit use of the product through using near baths or in showers, or any place where the unit may come in contact with water, the unit is not waterproof.
	Disassembly	Used to warn against self-repair or taking apart the unit by oneself, which could cause electric shock or other injuries.
	Unplugging	Used to indicate to the user when it is necessary to unplug the product, especially when it is showing signs of being damaged, or when a thunderstorm is expected.

# ■ Precautions on the use of Beauty Water and Strong Acidic Water as well as KANGEN Water



## Warning - Please observe carefully -



Please observe

- Please consult with your physician before using Beauty Water or Strong Acidic Water if you have any of the following.
  - Sensitive skin
  - Allergies
- If you experience any skin irritation after using any type of Beauty Water, discontinue use and consult with your physician.
- Please take the following precautions prior to drinking KANGEN Water:
  - Do not take medication with KANGEN Water.
  - Do not drink KANGEN Water if you have kidney problems such as kidney failure or trouble processing potassium.
  - If you experience any discomfort please discontinue use and consult with your physician.
  - If you are under the care of a physician please consult with them prior to drinking KANGEN water.
  - Do not use KANGEN Water with baby formula or baby foods.



## Attention



Prohibited

- Do not drink any of the following types of water; they may negatively affect your health.
  - Strong Acidic Water
  - Beauty Water
  - Cleaning cycle water
  - Water containing pH test liquid
  - Strong KANGEN Water during the production of Strong Acidic Water
  - Water being discharged from the secondary water hose
- When drinking KANGEN Water, adjust the pH value to 9.5 or lower. It is not recommended to drink water with a pH over 10.0. Check the pH regularly.
- Please drink the KANGEN Water as soon as possible after it is made.
- Do not use KANGEN or Beauty Water in fish bowls or aquariums; changes in pH may kill the fish.
- Do to the fact that copper containers are acid-sensitive and aluminum containers are alkaline-sensitive they should not be used.



Please observe

- Use containers made of glass, plastic, ceramic, or other non-corrosive materials when storing Strong Acidic Water. Metal containers will corrode when in contact with Strong Acidic Water and should never be used.
- Store Strong Acidic Water in a tightly sealed container that is impermeable to light. Use stored contents within one week.
- Metal knives or spoons cleaned with Strong Acidic Water or Beauty Water must be dried. Rust can develop if the utensils are left wet.
- Store KANGEN Water in a sealed container and keep refrigerated. Use the contents within 3 days.
- Run water through the machine for 15 minutes when you first use a new filter.
- Let the water flow for more than 10 seconds before your first use of the day.
- If the unit has been unused for 2~3 days, let the water flow for more than 30 seconds.
- Please follow local laws and regulations when disposing of used filters.

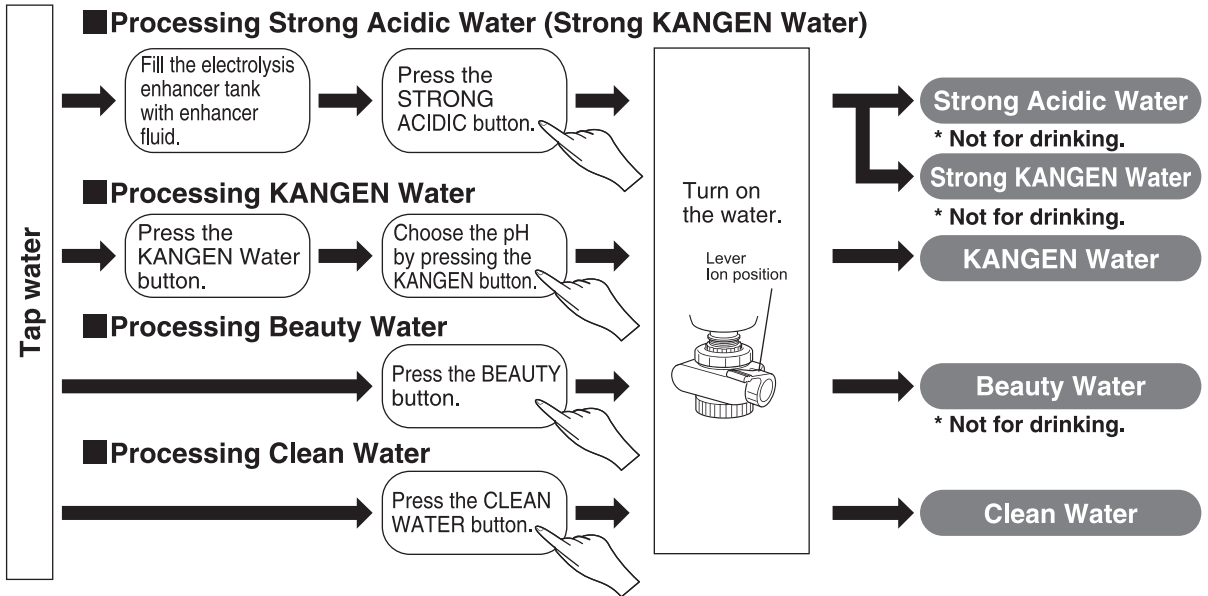

# Features

- This product is capable of producing 5 types of water, **Strong Acidic Water**, **Strong KANGEN Water**, **KANGEN Water**, **Beauty Water**, and **Clean Water**. All at a touch of the button to suit your specific needs.



- 5 types of water, subdivided into 7 according to pH, are available to suit your specific need.

Processed water	pH level	Use	⚠ ATTENTION
KANGEN Water	pH9.5	<b>Making herb tea, mild herb tea</b> Most suitable for making oolong tea.	Not to be used with medicine. When taking medicine, select the Clean Water mode.
	pH9.0	<b>Making green tea or coffee and cooking rice</b> Your green tea or coffee will taste mellow, and your rice will cook soft and full.	
	pH8.5	<b>Your Starting Point</b> This pH level is recommended for people to get used to KANGEN Water.	
Clean Water	pH is same as tap water.	<b>To be taken with medicine or preparing baby formula</b> This clean water can be used as water to be taken with medicine as well as water you can drink every day.	—
Beauty Water	pH6.0	<b>For your skin care</b> To be used as astringent water, bath water.	Not for drinking.
Strong Acidic Water	pH2.5	<b>To be used as disinfectant or cleaning</b> This water washes clean your kitchen utensils such as cooking knives, cooking boards, and washes cups and saucers stain-free. It also destroys pathogenic bacteria on fruit.	
Strong KANGEN Water	pH11.0	<b>Has the power to dissolve tough stains</b> Use the added power of Strong KANGEN Water to remove tough Kitchen grease stains or cleaning floors. Use to wash fish, meat, and vegetables.	

## Warning

(For producing various types of water, see "Usage" on P.16 and on.)



Please observe

When producing Strong Acidic Water, please make sure the room is well ventilated and avoid prolonged breathing of the vapors.



# Accessories

## • Accessories

### About installation

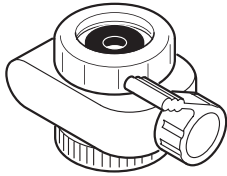

① Diverter

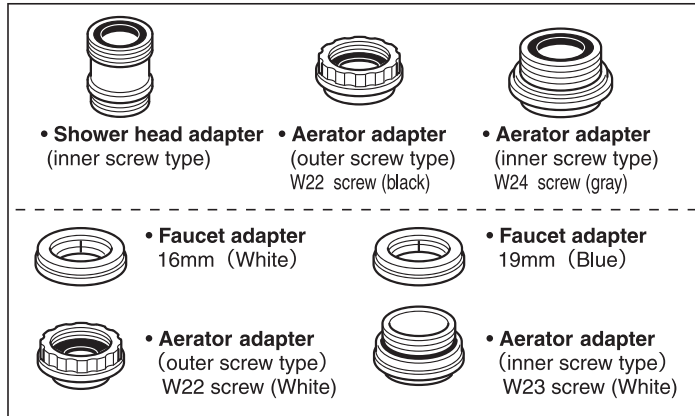

② 3-Pieces Adapter set and 4-Pieces Adapter set

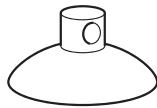

③ Suction cup (1 pcs.)

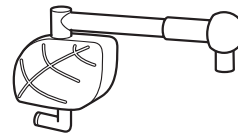

④ Secondary water stand (with suction pad)

### About the usage



⑤ Electrolysis enhancer



⑥ Funnel



pH test liquid



Test tube

pH color chart

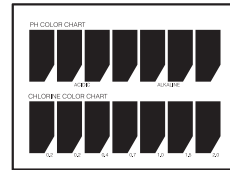

⑦ pH test liquid set

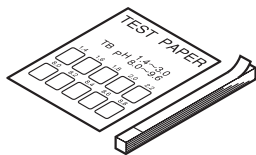

⑧ pH test paper

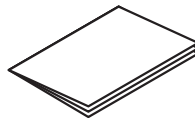

⑨ Operation manual



⑩ Water filter change label

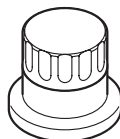

⑪ Cleaning powder Unit (CPU-N)



⑫ Cleaning powder

# Name of each part

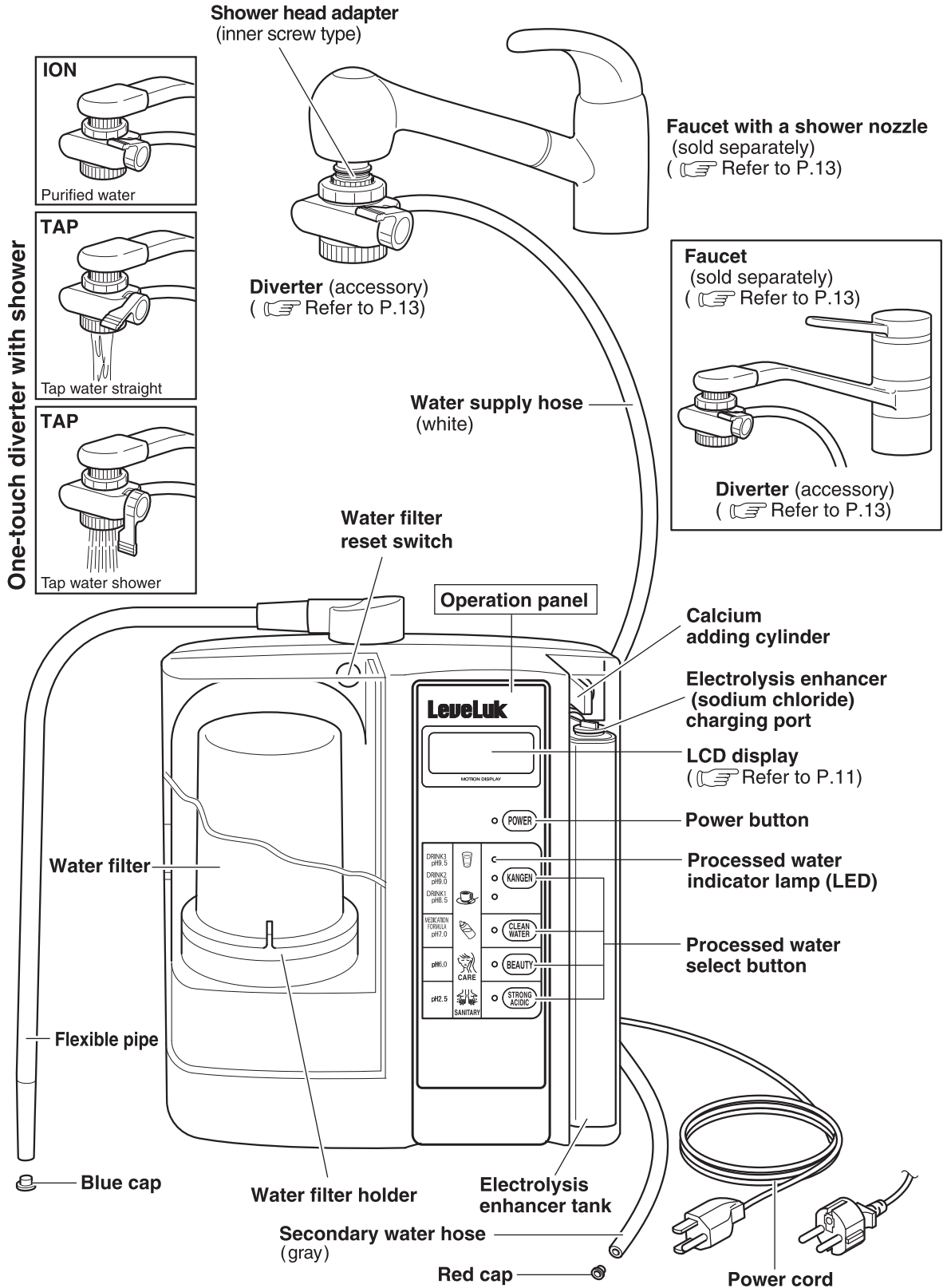

---

**<Top view>**

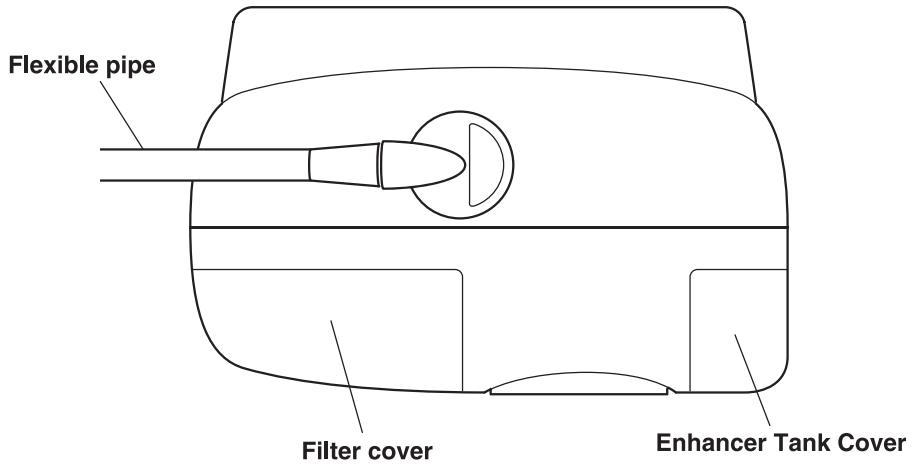

**<Bottom view>**

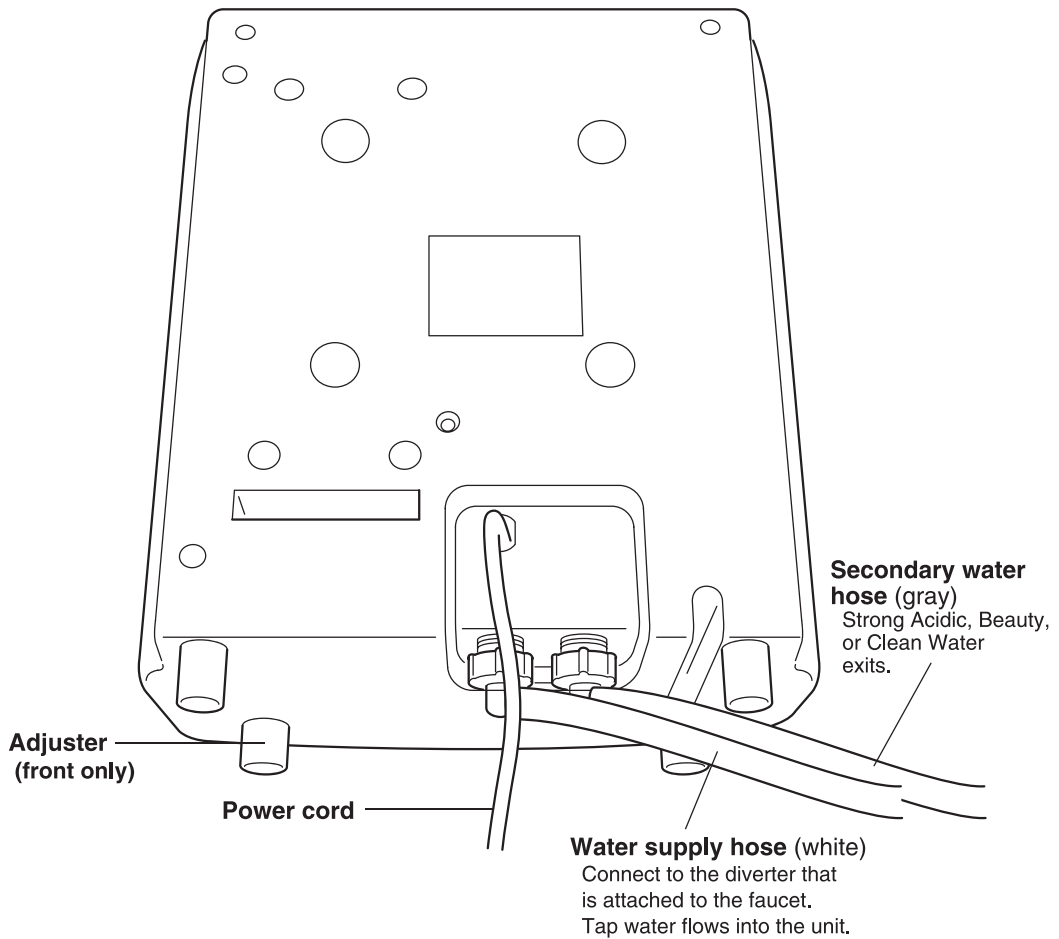

# Control panel

**Note: The unit has been shipped with the panel protective sheet over the control panel. Please peel off this sheet before using.**

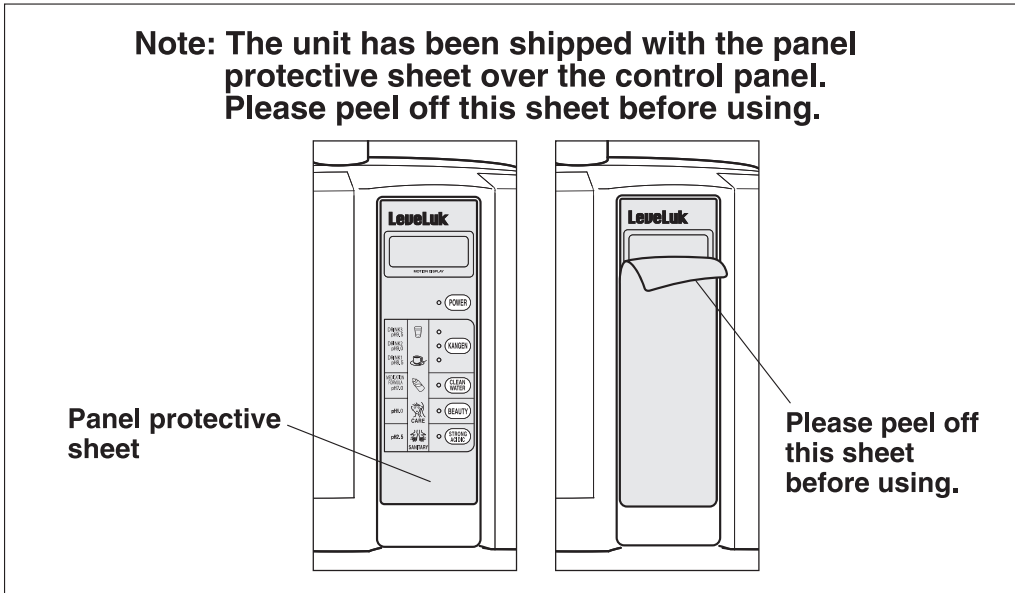

## Operation panel

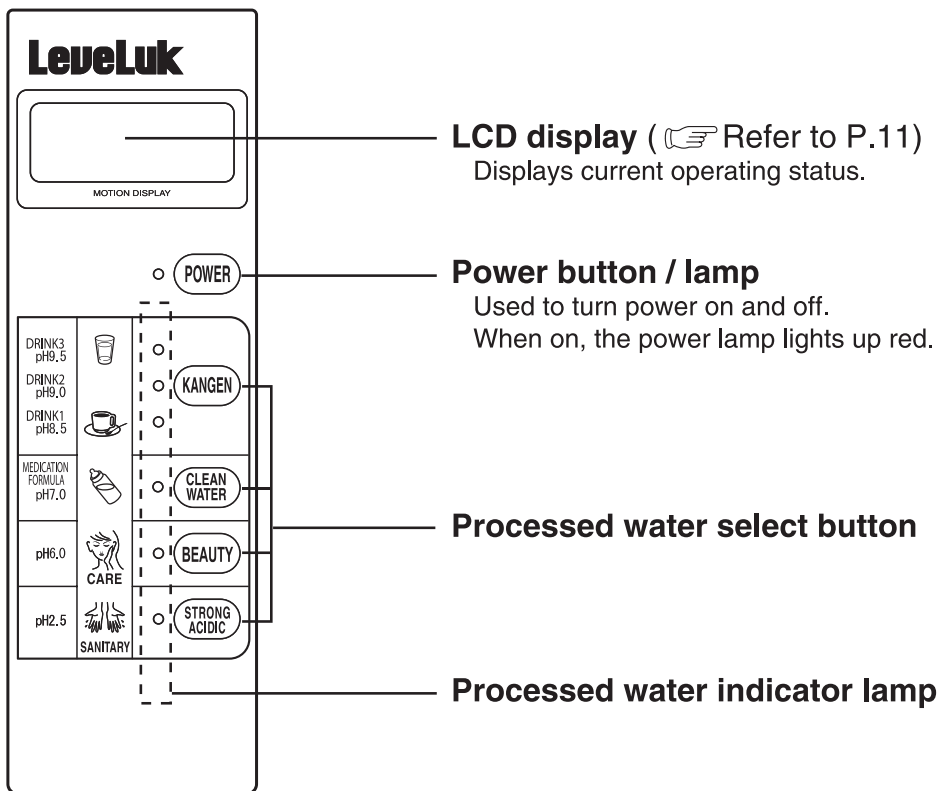

# LCD messages and voice guidance

## < Standby mode >

## < Operation Mode >

## < Other modes >

- When water supply (pressure) is insufficient

**KANGEN  
WATER**

KANGEN Water: 9.5  
KANGEN Water: 9.0  
KANGEN Water: 8.5



**KANGEN**  
>>>>>...

KANGEN Water 9.5  
KANGEN Water 9.0  
KANGEN Water 8.5

**BEAUTY  
WATER**

Beauty Water



**BEAUTY**  
>>>>>...

Beep  
+  
Beauty Water

**STRONG  
ACIDIC**

Strong Acidic Water



**STRONG**  
>>>>>...

Beep  
+  
Strong Acidic Water

**CLEAN  
WATER**

Clean Water



**CLEAN**  
>>>>>...

Clean Water

- When cleaning

**NOTICE  
CLEANING**

Notice of Cleaning



**CLEANS**  
>>>>>...

Beep  
+  
It Cleans it

- When switching sound level

**VOICE  
LOW**

Initial set-up (before shipment)



**VOICE  
LOUD**



**VOICE  
OFF**



- When water flow is too fast ( Beauty Water and Strong Acidic Water modes only)

**DECREASE  
FLOW**

Beep  
+  
Decrease Flow

- When running out of electrolysis enhancer or no electrolysis enhancer, while Strong Acidic Water production is in process

**RE-FILL  
SOLUTION**

Beep  
+  
Re-Fill Specified Solution

- When pressing the water filter reset switch

**FILTER  
RESET**

Beep  
+  
Filter Reset

- Displays for 3 seconds after plugging in the power cable.

○○○○○○H  
○○○○○○H

Switch-on operation is not possible while this is displayed. Press the Power Button when this display disappears.

**INCREASE  
FLOW**

Beep  
+  
Increase Flow

- When the unit is overheated

**HEAT  
PROTECT**

Beep  
+  
Heat Protection  
Close the faucet and switch it off. Then wait for more than 30 minutes or longer depending on the environment.

- When hot water enters

**HOT RUN  
PROTECT**

Beep  
+  
Hot Run Protection

- When water filter needs to be replaced

**REPLACE  
FILTER**

Beep

## ⚠ Attention

• Leveluk model has no Voice Guidance function.

# 1 Installation

## Selecting a location

### Attention



Please observe

- Do not place anything on the machine. (Trouble or falling may result.)
- Do not close the secondary water hose opening. (Can cause water leak or electrolytic error)
- Check the secondary water hose to see if it is twisted or bent. (Can cause water leak or electrolytic error)
- Keep the secondary water hose level lower than the level of the machine. (Otherwise, the water in the machine will not drain properly.)
- Do not move or transport the machine with electrolysis enhancer fluid in the electrolysis enhancer tank. May cause damage due to leaking fluid.

Install this system in compliance with state and local regulations.

### • Install in the following types of location

- In a well ventilated area

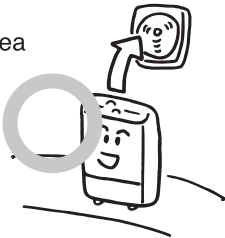

- An area away from flammable objects.
- In an area with room temperature between 41 to 104°F / 5 to 40°C.
- An area with relative humidity lower than 90%



- On a flat stable area capable of supporting the weight of the machine.

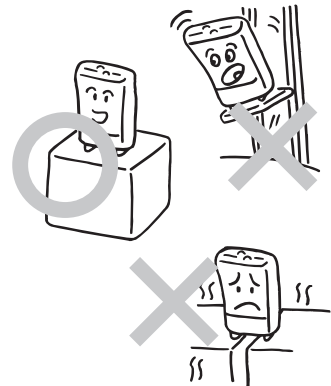

- An area not exposed to direct sunlight, wind or rain.

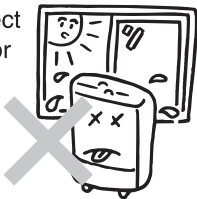

- An area free from splashing water, steam, chemicals and dust.



## ■ Installing the unit

Install on a kitchen counter.

\*Note: Install on a flat place.

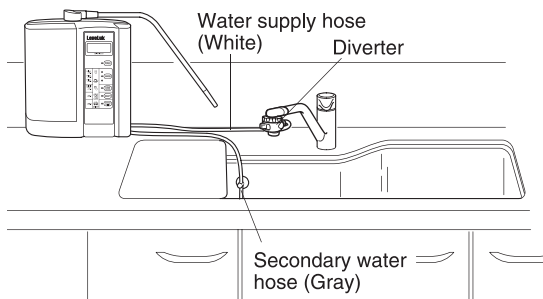

# Installing the diverter

**The diverter may fail to fit on some types of faucets. Check the type of faucet beforehand. Then fit the diverter on the faucet in the specified manner.**

## How to mount One lever faucet

### Inner screw type

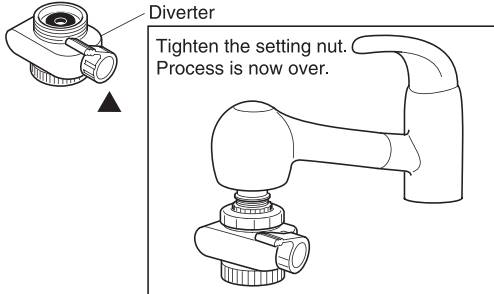
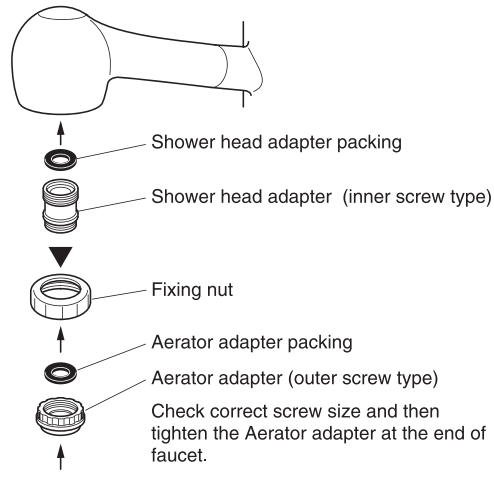
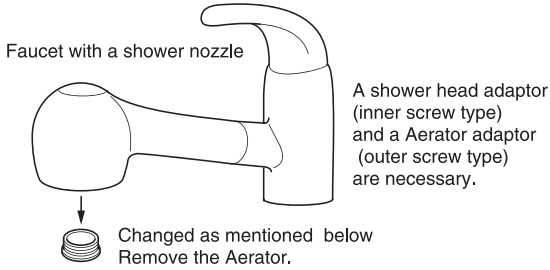

### Outer screw type

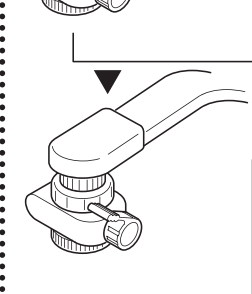
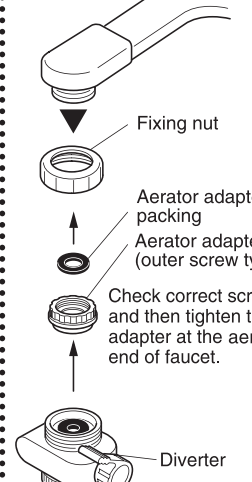
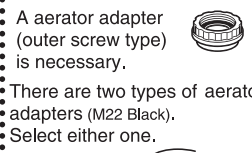
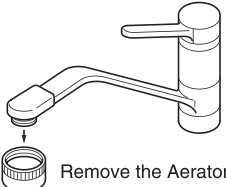

### Inner screw type

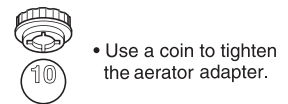
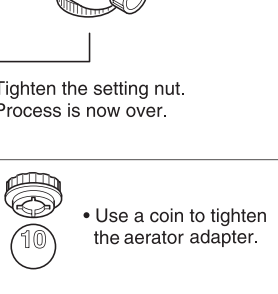
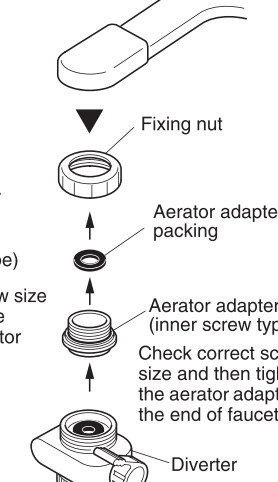
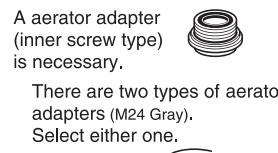
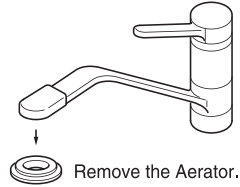

If the thread diameter or thread pitch does not fit, the threads may get damaged. Make sure the thread diameter and pitch are as specified.

**The faucets shown at right cannot accept the diverter.**

With a sensor	Screw diameter does not match	Faucet whose nossible part is short.	Square faucets
	<p>•When the accompanying adapter does not fit.</p>		

In this case, add a dedicated faucet or install the specific diverter. For details, contact your dealer.

# Setting up the unit

■ Install according to the order (1 to 4).

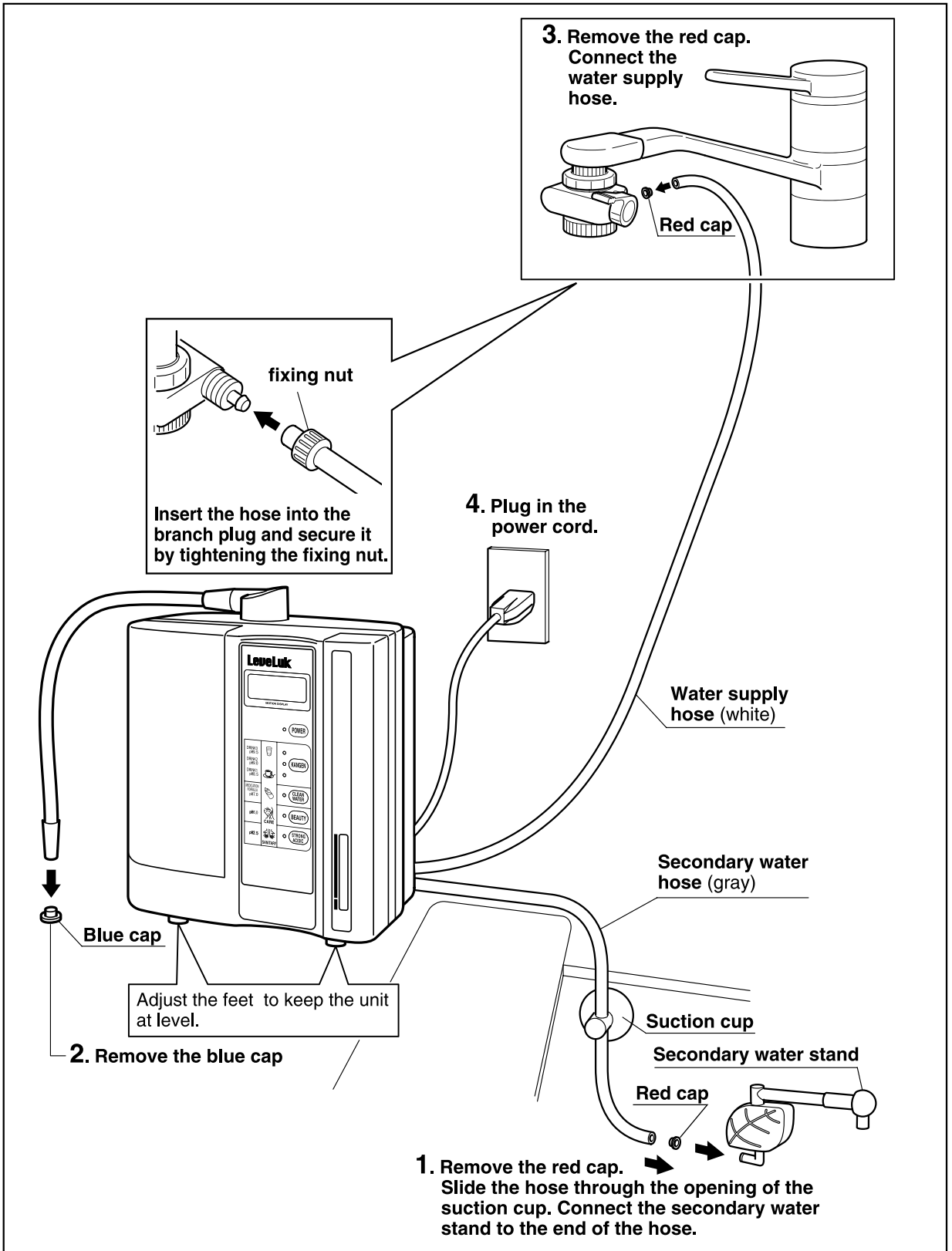



## About the power cable

■ Please use the outlet of AC120V · 60Hz (USA) / AC220—240V · 50/60Hz (Europe / Some parts of Asia) for household use.

※Using improper voltage will void the warranty.

### Warning

 Prohibited	<ul style="list-style-type: none"><li>• Never bend, pull, twist, or bundle the power cord. Do not lay heavy objects on top of the cord or clamp the cord: This may damage the cord, and cause electric shock that may lead to hazardous fire.</li></ul>
	<ul style="list-style-type: none"><li>• Do not use a damaged power cord or loosely fitted one. It may cause electric shock, short circuit or fire.</li></ul>
	<ul style="list-style-type: none"><li>• Stapling the power cord is strictly prohibited. This will cause irreparable damages to the cord and possibly fire.</li></ul>
	<ul style="list-style-type: none"><li>• Do not plug too many plugs into one outlet.</li></ul>
	<ul style="list-style-type: none"><li>• When cleaning the outlet, first disconnect the power plug. Dust on outlets can cause fire.</li></ul>
	<ul style="list-style-type: none"><li>• Connect or disconnect the power plug by holding the plug instead of the cord. Pulling the cord can cause breakage, fire, and/or electric shock.</li></ul>
	<ul style="list-style-type: none"><li>• Use only the proper power supply/ voltage. Using improper power source/voltage can cause fire or electric shock.</li></ul>
	<ul style="list-style-type: none"><li>• If the power cord gets damaged do not attempt to repair it yourself. Contact your local dealer to arrange for repairs.</li></ul>

### Attention

 Please observe	<ul style="list-style-type: none"><li>• Please be sure that the power cord can be easily unplugged prior to use.</li><li>• Be sure to check that all buttons work properly.</li><li>• Please bundle the cord during to storage to avoid damage.</li></ul>
	<ul style="list-style-type: none"><li>• A wet plug can cause electric shock. If the power plug is severely wet<ol style="list-style-type: none"><li>(1) Disconnect the plug from the outlet</li><li>(2) Wipe the water off the plugs</li><li>(3) Consult your local dealer for repairs</li></ol></li><li>• Never handle power plugs with wet hands. If power plug is wet, first disconnect it completely from the outlet and wipe it dry. Failure to follow these procedures may result in electric shock.</li><li>• Always unplug this product after use.</li></ul>



# Leveluk<sup>SD</sup> 501 · Leveluk<sup>DXII</sup>

## Changing the sound level

■ The sound level can be changed by selecting the button on the operation panel.

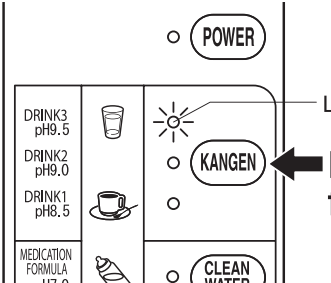
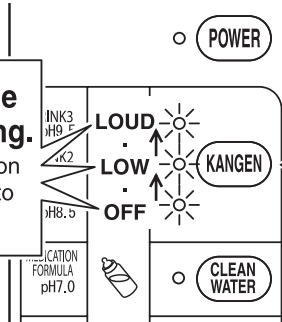
<p><b>1</b></p>	<p>With the power off, press the <b>(KANGEN)</b> button for about 3 seconds to select the sound level adjust mode.</p> <ul style="list-style-type: none"> <li>• The KANGEN Water lamp blinks.</li> </ul>	 <p>Lamp blinks.</p> <p>Press for 3 sec.</p>
<p><b>2</b></p>	<p>While the lamp is blinking, press the <b>(KANGEN)</b> button to select sound level.</p> <ul style="list-style-type: none"> <li>• Message on LCD (In sound level adjust mode)</li> </ul> <div data-bbox="198 956 1138 1188" style="border: 1px solid black; padding: 5px;"> <p>③ VOICE OFF → ① At Start time VOICE LOW → ② VOICE LOUD</p> <p>*Initial set-up (before shipment)</p> </div>	 <p>Press while the lamp is blinking. Each press of button changes the level to LOUD-OFF-LOW.</p> <p>Press</p>
<p><b>3</b></p>	<p>Once the sound level setting is complete, the power turns off after 15 seconds, or the power turns off immediately by pressing any button (such as POWER, CLEAN WATER, BEAUTY or STRONG ACIDIC) other than <b>(KANGEN)</b> button.</p> <ul style="list-style-type: none"> <li>• Return the unit to KANGEN Water mode by pressing the power button again.</li> </ul>	

### ⚠ Attention

• Leveluk<sup>DXII</sup> model has no  Voice Guidance function.

# Producing KANGEN Water

**Warning** Do not take medicine with KANGEN Water.

## Attention



Please observe

- Do not use processed water while the LED is blinking.
- When you begin to use it, throw away the stagnant water inside the device.
- Run water through the machine for 15 minutes when you first use a new filter.
- Let the water flow for more than 10 seconds before your first use of the day.
- If the unit has been unused for 2~3 days, let the water flow for more than 30 seconds.
- \* The first time the machine is used or after a filter change the water may appear cloudy. (The cloudiness is caused by settling of the activated charcoal filter. Continue to run the water until the cloudiness goes away. Do not drink the cloudy water.)

1

**Press the **POWER** button to turn on the power.**

- The POWER lamp comes on.

 **The button sound (Pip)+Voice guidance**

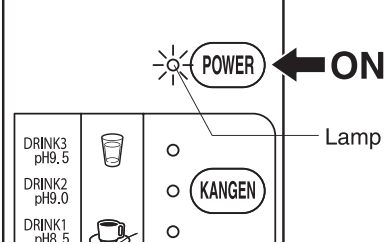

Lamp

2

**Press the **KANGEN** button to select the KANGEN Water mode and the pH value (pH9.5, 9.0 or pH8.5)**

- Each time the button is pushed it changes over the mode serially in 3 phases and the lamp comes on.

 **The button sound (Pip)+Voice guidance**

\* The pH value varies according to local water characteristics and water pressure.

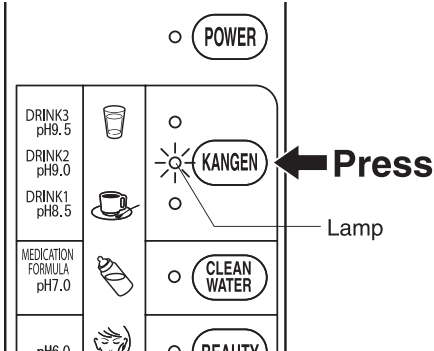

Lamp

3

**① Set the lever of the diverter to **ION** then run the water to begin processing water.**

**Attention**

- If the water flow (pressure) is too low, the voice guidance and alarm sound starts and the message appears on the display. (See P.11)
- \* Increase water flow.



**② Processed water will be discharged.**

- **KANGEN Water** is discharged from the flexible pipe.
- Beauty Water is discharged from the secondary water hose.

 **Voice guidance**

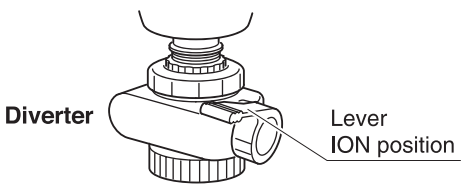

Diverter  
Lever ION position

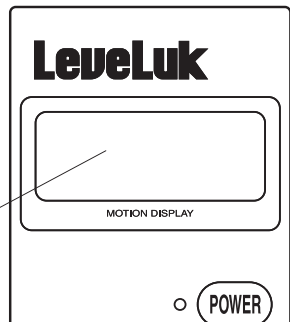

LCD display

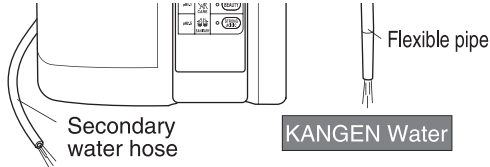

Secondary water hose  
Beauty Water **Warning**  
KANGEN Water

**NOT FOR DRINKING**

### How to stop operation

4

- Turn off the faucet to stop production of water. (If you wish to produce water continuously, follow step 3 of the operation procedure.)

**Attention** • **Leveluk** model has no Voice Guidance function.

## For adding glycerophosphoric acid calcium (optional)

- Take off the tank cover and turn the cap of calcium adding cylinder located at the top right corner of the unit clockwise to remove it. Add about 2 grams of glycerophosphoric acid calcium into the adding cylinder (to about 80% volume of the total cylinder capacity).

- Place the cylinder back in the cylinder cap, then return to its original location making sure the twist knob is vertical and in the closed position.

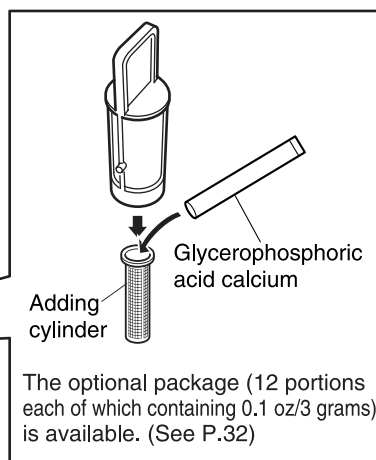
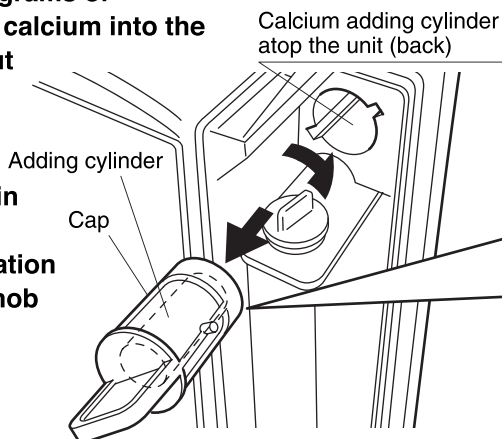

### Attention

- Glycerophosphoric acid calcium increase the calcium concentration in the KANGEN Water.
- This process also increases the pH concentration: Set the proper pH level of the unit by pressing the **KANGEN** button when adding glycerophosphoric acid calcium.
- If glycerophosphoric acid calcium is used, regular cleaning of the calcium cylinder is required so that no calcium clogs the cylinder screen.

## How to measure pH value of KANGEN Water

- Measure the pH value of the KANGEN Water by using the pH test liquid at least once a month.

Optimum pH

Potable range...pH8.5~9.5

### Attention

- The pH value varies according to local water characteristics and water pressure.

### pH test liquid set

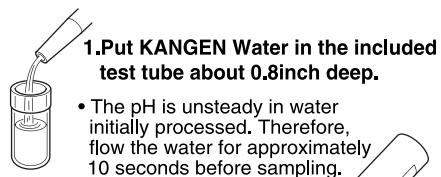

- The pH is unsteady in water initially processed. Therefore, flow the water for approximately 10 seconds before sampling.

2. Add about 1~2 drops of test liquid in the tube and shake the content well.



3. Compare the color of the water in the test tube with that of the color chart paper and check the pH concentration.

pH color chart

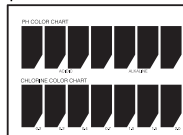





- Do not drink the water in the test tube after testing.
- Keep the testing liquid in a cold and dark place.
- Store the testing liquid out of children's reach.

# Producing Beauty Water

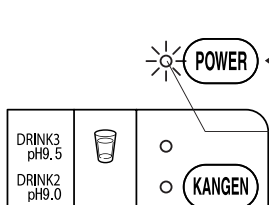
**Warning** This is not for drinking.

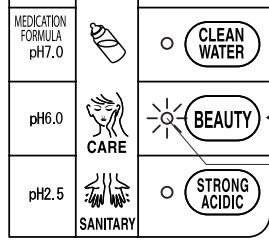
**Attention** • Leveluk  II model has no  Voice Guidance function.

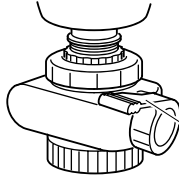
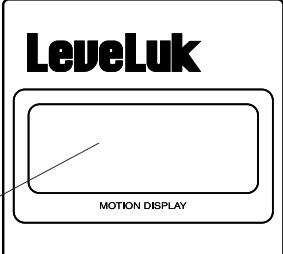
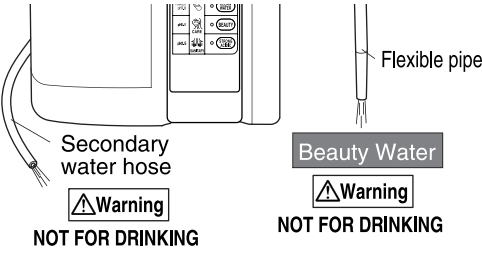
<p><b>1</b></p>	<p>Press the <b>POWER</b> button to turn on the power.</p> <ul style="list-style-type: none"> <li>• The POWER lamp comes on.</li> </ul> <p> The button sound+Voice guidance</p>	 <p>POWER ← ON</p> <p>Lamp</p> <p>KANGEN</p>
<p><b>2</b></p>	<p>Press the <b>BEAUTY</b> button.</p> <ul style="list-style-type: none"> <li>• The BEAUTY lamp comes on.</li> </ul> <p> The button sound+Voice guidance</p>	 <p>CLEAN WATER</p> <p>BEAUTY ← Press</p> <p>Lamp</p> <p>STRONG ACIDIC</p>
<p><b>3</b></p>	<p>① To begin processing Beauty Water turn the lever of the diverter to the <b>ION</b> position.</p> <p><b>Attention</b></p> <ul style="list-style-type: none"> <li>• When the flow rate (pressure) is too low, a message will appear on the display and the voice guidance and alarm will become audible. (See P.11)</li> </ul> <p style="text-align: center;">↓</p> <p>② Processed water will be discharged.</p> <ul style="list-style-type: none"> <li>• <b>Beauty Water</b> is discharged from the flexible pipe and a beeping sound will be made when water is produced.</li> </ul> <p> Voice guidance +Alarm sound</p>	 <p>Diverter</p> <p>Lever ION position</p>  <p>LCD display</p>  <p>Secondary water hose</p> <p>Flexible pipe</p> <p>Beauty Water</p> <p>Warning NOT FOR DRINKING</p> <p>Warning NOT FOR DRINKING</p>
<p><b>4</b></p>	<p><b>How to stop operation</b></p> <ul style="list-style-type: none"> <li>• Turn off the faucet to stop production of water. (If you wish to produce water continuously, follow step 3 of the operation procedure.)</li> </ul>	

# Producing Strong Acidic Water/Strong KANGEN Water ⚠ Warning These are not for drinking.

⚠ **Attention** • **Leveluk UF II** model has no 🗣 Voice Guidance function.

## ⚠ Warning

- When producing Strong Acidic Water, please make sure the room is well ventilated and avoid prolonged breathing of the vapors.

## ⚠ Attention

- To produce Strong Acidic Water, be sure to put the electrolysis enhancer in the tank unit before operating.
- Use genuine electrolysis enhancer recommended by manufacturer.
- While cleaning, let the water flow freely.

## ■ How to add electrolysis enhancer (attached)

① Take out the tank cover and remove the cap of the electrolysis enhancer port.

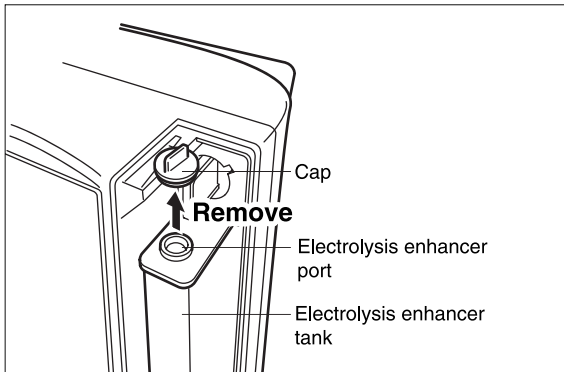

② Place the electrolysis enhancer into the tank from electrolysis enhancer port.

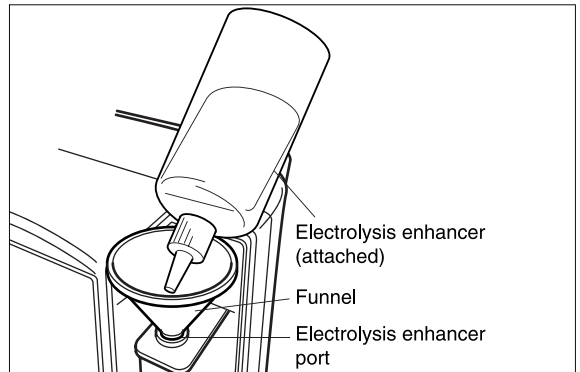

③ Replace the cap on the charging port and tighten it.

## ⚠ Attention

- After producing Strong Acidic Water, select another mode and continue to run the water until the cleaning mode stops. (about 30 seconds)
- Clean the electrolysis enhancer tank from time to time.

### <How to clean electrolysis enhancer tank>

① Remove the tank cover and take out the electrolysis enhancer tank.

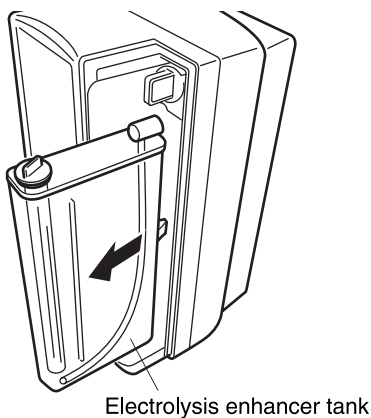

② Take off the cover from the electrolysis enhancer tank and clean the tank body.

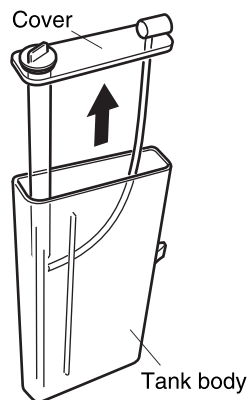

③ Replace the electrolysis enhancer tank in the original position and replace the cover.

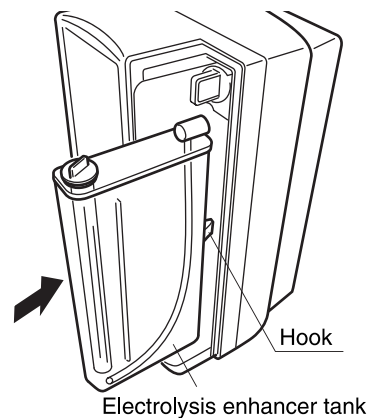

**1** Press the **POWER** button to turn on the power.

- The POWER lamp comes on.
- The button sound+Voice guidance

**2** Press the **STRONG ACIDIC** button.

- The STRONG ACIDIC lamp comes on.
- The button sound+Voice guidance

① Set the lever of the diverter to **ION** in order for the water supply faucet to open.

**⚠ Attention**

- When flow rate (pressure) is too low, a message will appear on the display and the voice guidance and alarm will become audible. (See P.11)
  - \* Increase water flow.
- When you use enhancer fluid for the first time or after refilling the enhancer tank, the machine will display "Re-Fill Solution" it will take about 20 seconds for the enhancer fluid to enter the electrolysis chamber.
- If the indication, "RE-FILL SOLUTION." does not go away in about 30 seconds lower the flow rate.

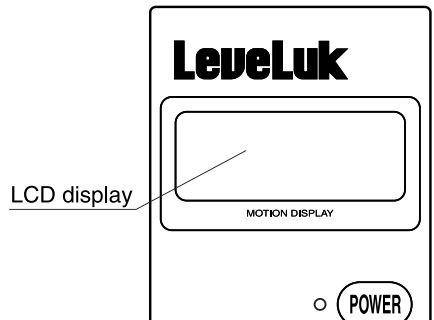
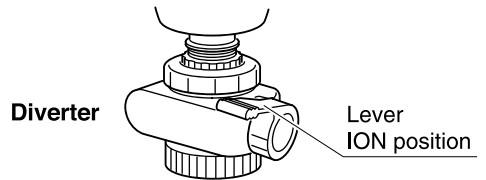

**3** ② Processed water will be discharged.

- Strong Acidic Water** is discharged from the secondary water hose and a beeping sound will be made when water is producing.
- Strong KANGEN Water is discharged from the flexible pipe.

Voice guidance +Alarm sound

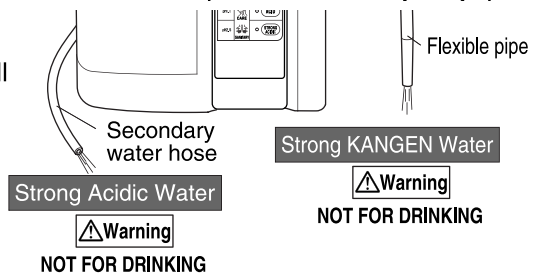

**⚠ Attention**



- If the electrolysis enhancer is too low, the voice guidance and alarm sound starts beeping and the message appears on the display. When this happens refill the electrolysis enhancer.
- After producing Strong Acidic Water, select another mode and continue to run the water until the cleaning mode stops. (about 30 seconds)





<b>4</b>	<div style="border: 1px solid black; padding: 2px; display: inline-block;">How to stop operation</div>
	<ul style="list-style-type: none"> <li>• Turn off the faucet to stop production of water. (If you wish to produce water continuously, follow step 3 of the operation procedure.)</li> </ul>

## How to measure pH value in Strong Acidic Water

● Measure by book pH test paper (attached)

### ■ How to use book pH test paper

<b>1</b>	<p>Carefully dip the pH test paper in the water sample (less than half a second). Then take it out immediately.</p>	
<b>2</b>	<p>Shake the pH test paper gently to remove excess water.</p>	
<b>3</b>	<p>Check the color of the wet portion of the paper to the standard color chart. *Color comparison and determination must be done in a brightly lit place.</p>	

## Attention



Please observe

- The pH test liquid (red) can not measure the pH below. For measuring the pH value of Strong Acidic Water, use the pH test paper.
- The pH test paper can only be used to check the pH value of Strong Acidic Water.
- Do not lick the pH paper. If you do, rinse out your mouth and gargle immediately.
- Dipping the test paper too long (longer than 0.5 sec) causes the pigment to be dissolved into the sample water resulting in inaccurate test results.
- The consequence of leaving the pH test paper exposed to air for a long period of time may lead to inaccurate results.
- The sample water must be kept at room temperature in order to prevent pigment from diffusing too rapidly.
- The pH test paper may look different depending on storage conditions. This will not affect any of its properties or abilities.
- The pH test paper must be kept in cool, dry, and dark places.

# Producing Clean Water

**⚠ Attention** • **Leveluk02II** model has no **🔊 Voice Guidance** function.

**1** Press the **POWER** button to turn on the power.

- The POWER lamp comes on.

**🔊** The button sound+Voice guidance

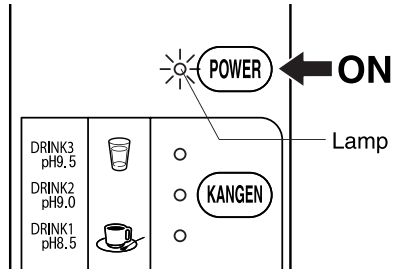

**2** Press the **CLEAN WATER** button.

- The CLEAN WATER lamp comes on.

**🔊** The button sound+Voice guidance

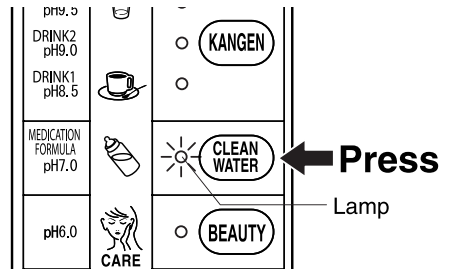

**①** Set the lever of the diverter to **ION** to let the water supply open.



**②** Processed water will be discharged.

- **Clean Water** is discharged from the flexible pipe.
- \*Do not use Clean Water discharged from secondary water hose.

**🔊** Voice guidance

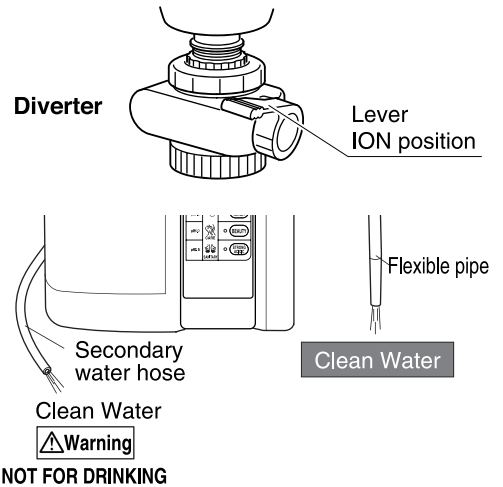

**3**

**⚠ Attention**

- Use the Clean Water discharged from the flexible pipe.
- Do not use processed water while the LED is blinking.

**4** **How to stop operation**



- Turn off the faucet to stop production of water. (If you wish to produce water continuously, follow step 3 of the operation procedure.)

# Automatic Cleaning

## ⚠ Attention

- **Leveluk QP II** model has no  **Voice Guidance** function.
- Never drink water produced during automatic cleaning.
- While cleaning, let the water flow freely.

Calcium deposited on the electrodes in the electrolysis tank may result in degraded water. This unit automatically cleans the tank.

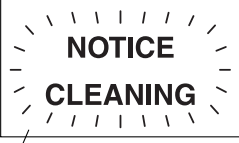
1	<p><b>&lt;Cleaning on&gt;</b></p> <p> <b>Voice guidance</b> + <b>Alarm sound</b></p> <p>LCD display  <b>&lt;Water running&gt;</b> <b>CLEANS</b> &gt; &gt; &gt; &gt; <b>Beep, beep, beep</b></p>	<ul style="list-style-type: none"> <li>• When the unit produces KANGEN Water, Beauty Water or Strong Acidic Water, the time for use reaches 15 minutes, and then the unit will announce Automatic cleaning.</li> <li>• Once the announcement of cleaning is made, the unit will start cleaning automatically for 30 seconds when the production of <b>KANGEN</b>, <b>BEAUTY</b>, <b>STRONG ACIDIC</b> or <b>CLEAN WATER</b> is taking place.</li> </ul> <p><b>⚠ Attention</b> While the unit is producing the 4 kinds of water listed above, the unit will not switch over to the automatic cleaning mode. The unit will automatically clean the next time the unit is productive.</p>
2	<p><b>&lt;Message informing you that the unit is cleaning &gt;</b></p> <p> <b>Voice guidance</b></p> <p>LCD display  <b>&lt;During stand by&gt;</b> <b>NOTICE</b> <b>CLEANING</b> <b>Water producing and cleaning modes alternately displayed</b></p>	<ul style="list-style-type: none"> <li>• If cleaning is necessary at the beginning of the next production, the unit will issue a notification as referred on the left. The screen will display the type of processed water you have selected on the LCD and the cleaning mode alternately.</li> </ul>

## The unit cleans automatically in the following cases:

- ① The total operating time has reached 15 minutes.  
(After producing KANGEN Water, Beauty Water or Strong Acidic Water, the unit issues a notice of automatic cleaning and puts itself in standby mode. \*Excluding Clean Water)
- ② After producing Strong Acidic Water, when producing KANGEN Water, Beauty Water or Clean Water.
- ③ When the unit is not used for 24 hours or more.

## ⚠ Attention

- When disconnecting the power plug, please disconnect the power plug after turning off power switch.

# 3 Replacing the water filter (HG-N)

**⚠ Attention** • **Leveluk**  model has no  Voice Guidance function.

■ The water filter is a standard accessory that comes with a new unit.  
(Replacement activated charcoal water filters are available. Contact your local dealer.)

When the filter needs to be replaced, the unit issues a notification through voice guidance, alarm sounds and the LCD on the operation panel when the water supply is stopped. (The processed water selected and filter replace mode signals will alternately be displayed.)

- When water filter needs to be replaced

 Voice guidance+Alarm +

**REPLACE  
FILTER**

LCD display

**⚠ Attention**

- The "REPLACE FILTER" message does not appear while water is running.
- Replace the water filter after stopping the water.

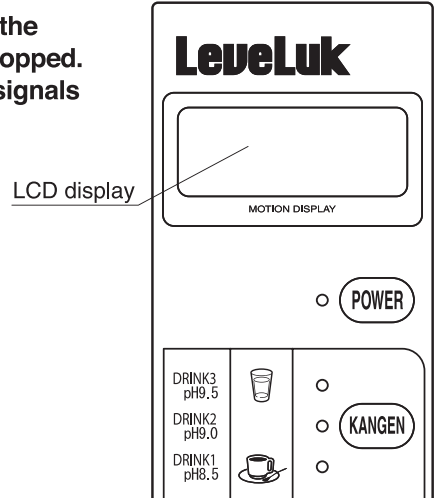

1

Push the water filter cover hook on the left side of the unit and remove the cover.

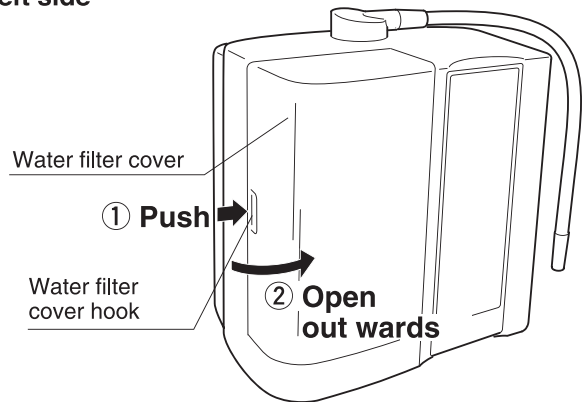

2

Turn the holder knob clockwise about 40 degrees to unlock the holder. Lift and take out the water filter.

**⚠ Attention**

- Be careful of water leaking out of the filter when removing the filter.

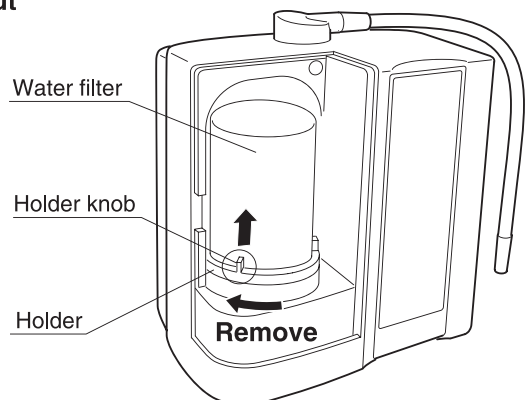

3

Check that the old O-ring remains on the body or mounting position well, and then insert the water filter firmly.  
Turn the holder knob counterclockwise about 40 degrees to lock it.

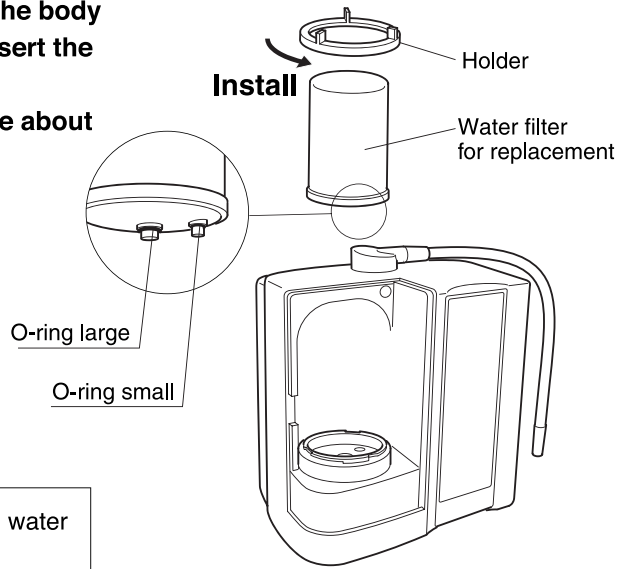

**⚠ Attention**

- Check to see if 2 O-rings are fixed on the water filter.
- Check to see if the holder is inserted firmly.

4

Press the water filter reset switch.  
The voice guidance and alarm (Beep) sound and a message “FILTER RESET” is displayed on the LCD.

 Voice guidance + Alarm sound (Beep)



Replace the water filter cover.

Water filter reset switch

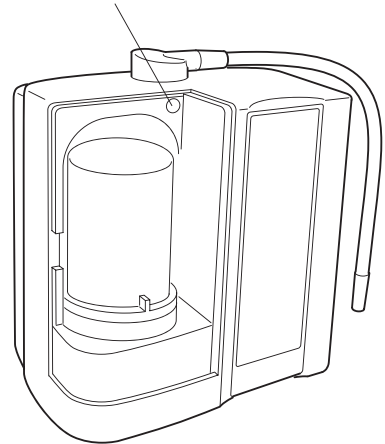









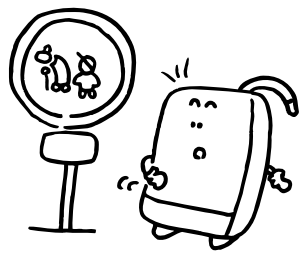

**⚠ Attention**

- Be sure to use our genuine water filter for replacement. (Never use other manufactures' filters, as they may cause malfunction or other troubles.)
  - Pour water into the device for more than three minutes when you use the device first or when you use the new water filter.
  - Please ensure that the spent water filter (combustibles) observe the regulations of the region.
- (The material of water filter case is ABS resin. Please refer to page 33 standard specifications for inside filtering material.)

# 4 Safety Precautions

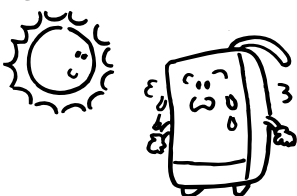
■ To avoid injury or accident, please adhere to the following rules.

 <b>Warning</b>	
<p> Prohibited</p> <ul style="list-style-type: none"> <li>• People who have the following conditions should get doctor's or pharmacist's approval before drinking KANGEN Water generated with this water processor.</li> <li>• Please take the following precautions prior to drinking KANGEN Water.               <ul style="list-style-type: none"> <li>■ Do not take medication with KANGEN Water.</li> <li>■ If you experience any discomfort in your health condition, please consult your physician or pharmacist.</li> <li>■ If you are under a physician care, or are experiencing physical abnormality, please consult your physician or pharmacist before using.</li> </ul> </li> <li>• Use only municipally treated water approved for drinking such as tap water.               <ul style="list-style-type: none"> <li>■ The unit's chlorine removal ratio and pH value may vary according to the water quality of different localities.</li> </ul> </li> </ul> 	<ul style="list-style-type: none"> <li>• Please supervise children and senior citizens while they use the machine.</li> </ul> <p> Please observe</p> 

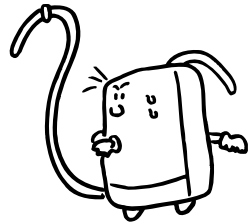
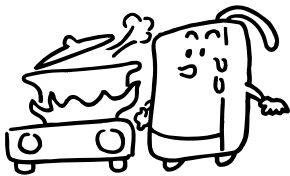
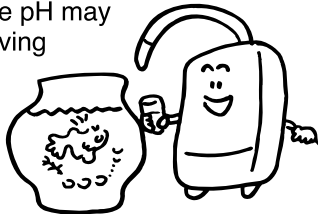
 <b>Attention</b>	
<ul style="list-style-type: none"> <li>• <b>Avoid direct sunlight.</b></li> <li>- May cause the unit to bend or warp. -</li> </ul> 	<ul style="list-style-type: none"> <li>• <b>Do not use thinner, benzene, cleansers or chlorine-based detergents for cleaning.</b></li> <li>- May damage the unit. -</li> </ul> 
<p> Please observe</p> <ul style="list-style-type: none"> <li>• <b>Do not splash water or oil on the body.</b></li> <li>- May cause fire or electric shock. -</li> </ul> 	<ul style="list-style-type: none"> <li>• <b>Do not use the unit when the secondary water hose is in an elevated position.</b></li> <li>- Water cannot flow out of the unit and therefore it may cause damage. -</li> </ul> 
<ul style="list-style-type: none"> <li>• <b>Do not place the unit near hot objects or in the presence of corrosive gas.</b></li> <li>- May damage or cause the unit to bend or warp. -</li> </ul> 	<ul style="list-style-type: none"> <li>• <b>Do not use processed water in aquariums or give to pets.</b></li> <li>- The change in the pH may kill fish or small living creatures. -</li> </ul> 

## ⚠ Attention

- **Never place anything on the unit.**
- It may cause damage or fall. -



- **Do not use salt water or excessively hard water.**
- The unit may be damaged, or its service life will be shortened. -

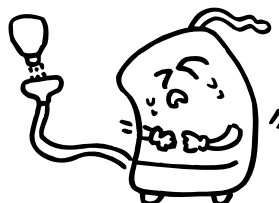

- **If you want to move the unit, first remove the electrolysis enhancer tank.**
- Leaking from the electrolysis enhancer may cause trouble. -

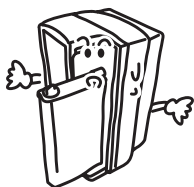

- **Never run hot (40°C or higher) into the unit.**
- It may damage or cause malfunctions. -

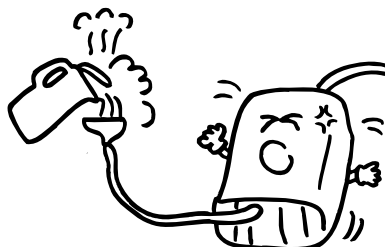

- **Never run the unit with a damaged power supply cord.**
- It can cause a fire, electric shock or malfunction. -

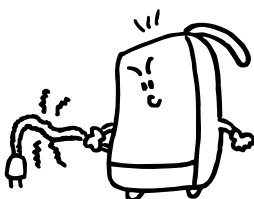

- **When using the unit in a area with cold temperatures please avoid running freezing water into the unit (When you are not using the unit for a long period of time, remove the water filter and keep it separately from the unit. At the time, do not touch the reset switch).**
- Failure to do so can result in damage or malfunction. -



- **Do not tamper with or attempt to repair the unit.**
- It can cause a fire, electric shock or accidents. -

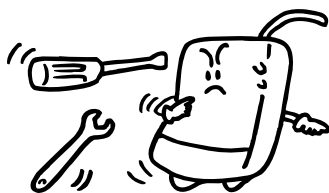

Please observe

# 5 Troubleshooting

• Use the following guide to self check your problems before contacting the company.

Trouble	Cause	Remedy
No power is supplied. (Power lamp doesn't come on)	• Unit is not plugged the outlet.	• Insert the power plug into the outlet.
Alarm sounds.	• Defective condition present.	• Follow the instruction on LCD display.
No water comes out. Output of all types of water is getting low.	• The inside the unit is frozen.	• Raise the room temperature and wait until it melts.
	• Water flow (pressure) is low.	• Open the faucet wider.
	• Water filter has clogged.	• Replace the water filter with a new one.
	• Cleaning timing.	• Clean using a E-Cleaner N.
	• The hose is bent.	• Smooth out the hose not to be bent.
Nasty odor or taste.	• KANGEN Water pH concentration is too high.	• Lower the pH concentration.
	• Such odor or taste is coming from the water remaining inside.	• Flow Let the water for a while and completely drain the water inside the tank.
KANGEN Water has chlorine odor.	• Water filter needs to be replaced.	• Replace the water filter with a new one.
Whitish material is floating or has settled in KANGEN Water.	• Calcium processed by electrolysis.	• Change over to Beauty water and let the water flow for a few minutes.
	• Cleaning timing.	• Clean using a E-Cleaner N.
The inside of secondary water hose is stained dark.	• Oxidizing material, such as iron has adhered.	• Harmless.
Acidic Water does not go lower than pH2.7 when the Strong Acidic Water switch is selected.	• Output of water is too high.	• Reduce the water plug opening.
	• No electrolysis enhancer.	• Refill electrolysis enhancer.
Dropping pH value when processing KANGEN Water and Beauty Water.	• Calcium buildup in the ionizing cell.	• Press the BEAUTY button and run water for about 1 minute to clean the ionizing cell.
	• Cleaning timing.	• Clean using a E-Cleaner N.



## **Attention** · Reactions of pH test liquid with ground water containing free carbonic acid

• In the event that ground or well water is used in place of tap water, because of the ionization of free carbonic acid in the water, the pH of KANGEN Water may return to neutral 1~2 seconds after electrolysis (the pH test liquid turns from blue to green). Despite this, KANGEN Water retains many of its characteristics, tastes good, and benefits.

- **Test method:** Put 3 or 4 drops of the pH test liquid in an empty transparent glass. Pour KANGEN Water (pH 9.5) in the glass.
- **Reactions** : The solution turns somewhere between royal purple and blue just after adding the KANGEN Water and from blue to green in 1~2 seconds.

## Cleaning with a E-Cleaner N

Cleaning Powder Unit (CPU-N)  
(※Replace when CPU-N is broken.)

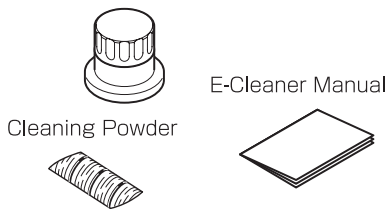

 **Attention** Please use the cleaning powder once every week or two weeks.

- Be sure to shut off the faucet and turn off the unit before cleaning.
- Always turn the power off and disconnect the plug.
- Please only use one pack of the cleaning powder fabricated by the manufacturer for each individual treatment. Using another cleaning powder could cause internal damage to the unit.

The cleaning powder includes citric acid so avoid using the water during cleaning mode to sanitize all fruits and vegetables.

### Cleaning machine

- Use E-cleaner once every week to two weeks. -

We recommend deep cleaning once a year at a qualified service center. Deep cleaning intervals may vary, depending on hardness of source water. Water softener is recommended only for extremely hard water sources.

① Unscrew the cap of the CPU-N (Cleaning Powder Unit), pour the cleaning powder evenly into the bottom, and retighten the cap.

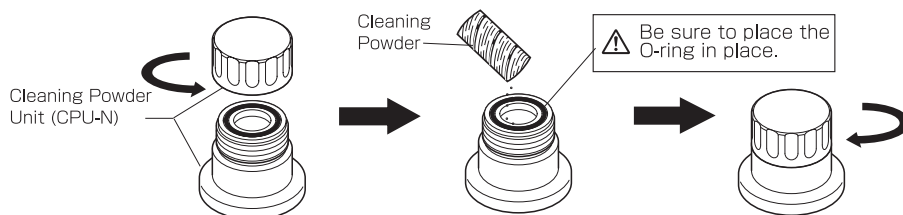

② **After turning off the water faucet,** remove the filter cover from the main unit, rotate the holder and remove the water filter.

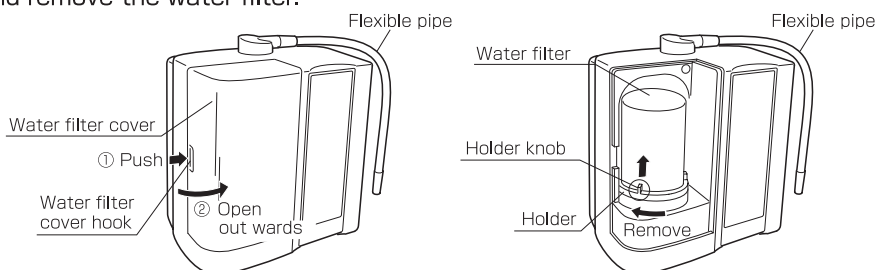

③ Place the cleaning powder unit on the main unit, and secure the unit in place with the holder.

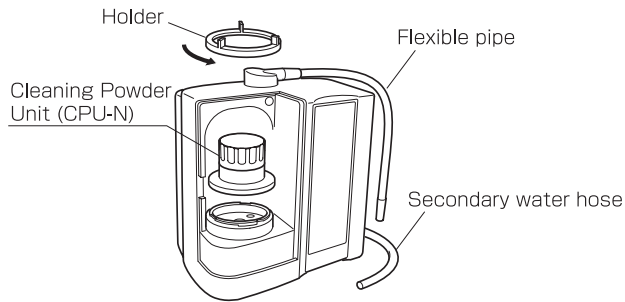

④ Turn on the faucet to allow the water to flow through the flexible pipe for approximately 10 seconds (approx. 1 liter), then turn off the water.

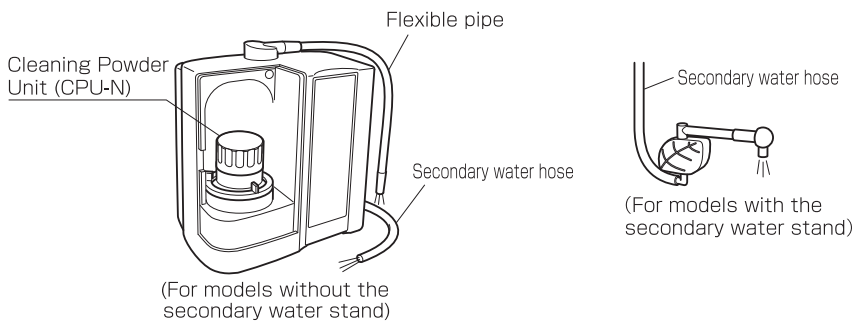

⑤ Place the tip of the flexible pipe and secondary water hose/secondary water stand at the bottom of a cup, and allow the water to flow through the pipe until the cup is half-full of water. Turn off the faucet, and leave the pipe and hose in the cup for three to five hours.

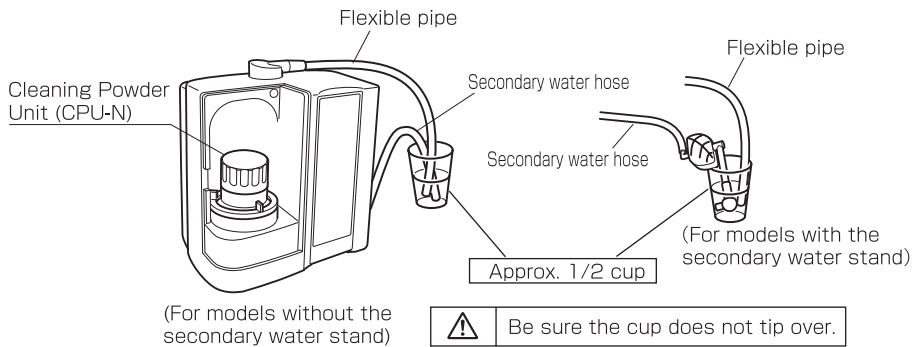

⑥ Remove the cup after three to five hours. Turn on the faucet and allow water to flow through for several minutes.

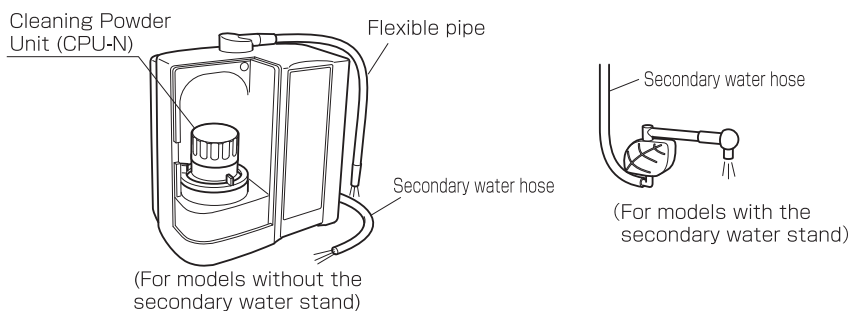

- ⑦ **Turn off the faucet**, and then replace the water filter that was removed in step 2. Turn on the faucet and allow water to flow through for several minutes.

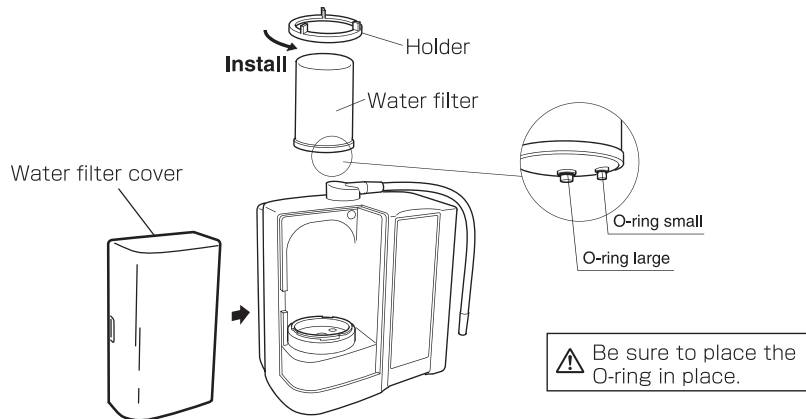

- ⑧ Reattach the filter cover and plug in the electrical cord. The cleaning process is now complete.
- ⑨ After completing the cleaning process, deposits may flow out for a while during use. Discard the water if deposits are found in it.
- ⑩ After using the CPU-N, rinse the unit with tap water thoroughly, and dry it off completely with a soft cloth and store the unit in a dry place.
- ⑪ If the O-ring or the cap is damaged, replace it immediately. The CPU-N is a consumable item. Please purchase a new one on a regular basis.

# 6 Options

## • Options



① Screw fixed adapter

② Flexible pipe  
32inch / 800mm long

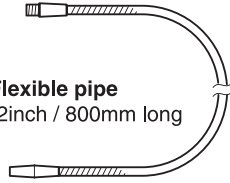

③ Chlorine reagent (0.5oz/15ml)  
(residual chlorine measuring reagent)  
USA only

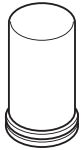

④ Water filter for replacement  
Activated charcoal type  
HG-N



⑤ Water supply hose  
(40 - 200inch)

⑥ Secondary water hose  
(40 - 200inch)



⑦ Electrolysis enhancer



⑧ Glycerophosphoric acid calcium  
(12 pcs. 0.1oz/3g each)

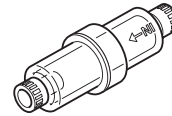

⑨ Pre-filter



⑩ DPS Replacement Filter



⑪ pH test liquid



⑫ Test tube

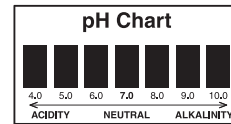

⑬ pH color comparison table

pH test liquid goods

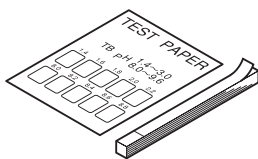

⑭ Book pH test paper

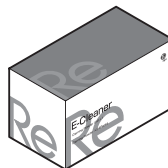

⑮ E-Cleaner N  
Cleaning powder Unit (CPU-N)  
Cleaning powder (24 pcs.)



⑯ Cleaning powder (24 pcs.)

# 7 Standard specifications

Item name		LevelLuk <sup>SD</sup>	LevelLuk <sup>DXII</sup>	LevelLuk <sup>JrII</sup>
Feed water specs and connection		ONE way diverter		
Power supply		(USA) AC120V 60Hz 3.2A		
Rated current		(Europe /parts of Asia) AC220—240V 50Hz/60Hz 1.6A		
Power consumption		Max. approx. 230W (If production is done at a high KANGEN pH level)	Max. approx. 200W (If production is done at a high KANGEN pH level)	Max. approx. 120W (If production is done at a high KANGEN pH level)
Main unit	dimensions	13.3(H) x 10.4(W) x 6.7(D)inch / 338(H) x 264(W) x 171(D)mm		
	weight	13.9 lbs / 6.3kg		
Ionizing system		Continuous ionizing system (Built-in flow rate sensor)		
Electrolysis	KANGEN Water	0.7~1.1gal. / min. 2.5 ~ 4.0L / min.	0.5 ~ 0.8gal. / min. 2.0 ~ 3.0L / min.	0.4 ~ 0.7gal. / min. 1.7 ~ 2.5L / min.
	Feed water pressure Approx.	14.5psi / 100kPa		
	Strong Acidic Water	0.2 ~ 0.3gal. / min. 0.6 ~ 1.2L / min.	0.1 ~ 0.25gal. / min. 0.5 ~ 1.0L / min.	0.1 ~ 0.2gal. / min. 0.3 ~ 0.7L / min.
	Feed water pressure Approx.	15psi / 100kPa	12psi / 80kPa	9psi / 60kPa
	Electrolysis capacity settings	7 levels	KANGEN Water at 3 levels (Approx. pH8.5 / pH9.0 / pH9.5) Clean Water (Approx. pH7.0) Beauty Water (Approx. pH6.0) Strong Acidic Water (Approx. pH2.5) Strong KANGEN Water (Approx. pH11.0)	
	Cleaning system of ionizing cell	Automatic cleaning system		
Materials of electrode and ionizing cell		Platinum-plated titanium		
Water filter	Filter material	Granulated antibacterial activated charcoal, calcium sulfite		
	Removable substance	Aesthetic Chlorine, Taste and Odor up to 1500 gallons.		
	Un-removable substance	Metal ions/salt dissolved in original tap water		
	Replacement interval	Varies according to region and water quality		
Applicable water pressure		7-60 psi on PDS / 50kPa ~ 450kPa (Approx. 0.5kgf/cm <sup>2</sup> ~ 4.5kgf/cm <sup>2</sup> )		
Continuous use max. water temperature		41 ~ 95°F / 5 ~ 35°C		
Electrolysis enhancer (for Strong Acidic Water production)		Forced dissolving adding type		
Electrolysis enhancer (sodium chloride) re-fill need indication		Voice guidance, Alarm sound, LCD message( <b>LevelLuk<sup>JrII</sup></b> excepts voice guidance (guidance))		
Protective device		AC120V 60Hz	Current fuse 6A	AC220V 50Hz/60Hz Current fuse 3A
Detective device		Detection of temperature rise and hot water		

- Specifications and design subject to change for product improvements without notice.
- The electrolytic processing capacity and the filter service life largely depend on the water quality or how the machine was used.

# MEMO

---



# After-sales Service

## Warranty

•Please keep the included warranty in a safe place for future reference.

## If you need repair during warranty period

•For repairs, please contact your local dealer.

(Please read the warranty carefully, some repairs may not be covered under the warranty.)

**⚠ Attention** \*You may be charged if your repair is for any of the following reasons.

1. Trouble resulting from handling in a manner that is not specified in the "Operation Manual".
2. Trouble or damage due to the use of water other than municipal drinking water.
3. Trouble or damage due to natural disaster, such as, earthquake, fires or floods.
4. Dropping the product or damage caused during transportation.
5. Damage caused by use of improper voltage.
6. Replacement of consumable parts.
7. Replacement of spent electrode.
8. Trouble resulting from improper usage or failure to perform regular maintenance.
9. Trouble resulting from tampering or altering.
10. Trouble caused by sediment or lime scale deposits.

## If you need to repair after warranty expiration

•Contact your local dealer. Repair may be available upon request at purchaser's expense.

## Others

•If you have any questions about the product, please contact your dealer.

For use with cold water only.

Do not use with water that is microbiologically unsafe or of unknown quality without adequate disinfection before or after the system.

## ⚠ Warning



In no case should the product be modified, overhauled or repaired by purchaser, as fire or electrical shock could result.

Any consequences of such behavior shall not be compensated by the maker.

\* For questions and information, please contact your local dealer.

**Los Angeles (US Headquarters)**  
tel.1-310-542-7700 fax.1-310-542-1700  
**New York**  
tel.1-718-784-2110 fax.1-718-784-2103  
**Chicago**  
tel.1-847-437-8200 fax.1-847-437-8201  
**Texas**  
tel.1-972-722-7499 fax.1-972-722-7402  
**Florida**  
tel.1-407-601-5963 fax.1-407-730-3335  
**Seattle**  
tel.1-425-640-2222 fax.1-425-672-8946  
**Honolulu**  
tel.1-808-949-5300 fax.1-808-949-5336  
**Vancouver**  
tel.1-604-214-0065 fax.1-604-214-0067  
**Toronto**  
tel.1-905-507-1200 fax.1-905-507-1233  
**Mexico**  
tel.52-81-8242-5500 fax.52-81-8242-5549

**Germany**  
tel.49-211-9365-7000 fax.49-211-9365-7027  
**France**  
tel.33-01-4707-5565 fax.33-01-4707-5595  
**Italy**  
tel.39-06-3330-670 fax.39-06-3321-3189  
**Australia**  
tel.61-2-9878-1100 fax.61-2-9878-1200  
**Philippines**  
tel.63-2-519-5508 fax.63-2-519-1923  
**Singapore**  
tel.65-6720-7501 fax.65-6720-7505  
**Malaysia**  
tel.60-3-2282-2332 fax.60-3-2282-2335  
**Hong Kong**  
tel.852-2154-0077 fax.852-2154-0027  
**Taiwan**  
tel.886-2-2713-2936 fax.886-2-2713-2938  
**Korea**  
tel.82-2-546-8120 fax.82-2-546-8127

**Sapporo**  
tel.81-11-223-5678 fax.81-11-223-5680  
**Tokyo**  
tel.81-3-5205-6030 fax.81-3-5205-6035  
**Sikoku**  
tel.81-897-58-4115 fax.81-897-58-4116  
**Okinawa**  
tel.81-98-878-4132 fax.81-98-878-4141  
**Nago**  
tel.81-980-51-0616 fax.81-980-51-0628  
  
Manufacturer:  
**Enagic, Inc.**  
tel.81-72-893-2290 fax.81-72-893-8007

Made in Japan. 2013.06

46-0045F